

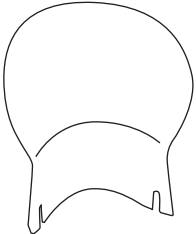

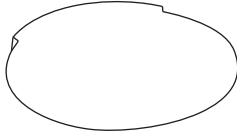



<p>01</p>  <p>encosto PP</p>	<p>02</p>  <p>assento PP</p>	<p>03</p>  <p>sapatas x 4</p>
<p>04</p>  <p>estrutura fixa</p>		<p>a)</p>  <p>parafuso PH PAN AA 5,5X32 (X4)</p>

Passo 01: Posicionar a estrutura (item 04) sobre um apoio e encaixar as sapatas (item 03). Para melhor fixação bater com martelo de borracha.

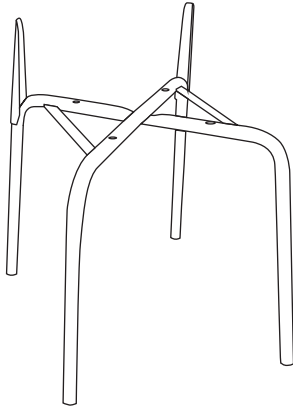

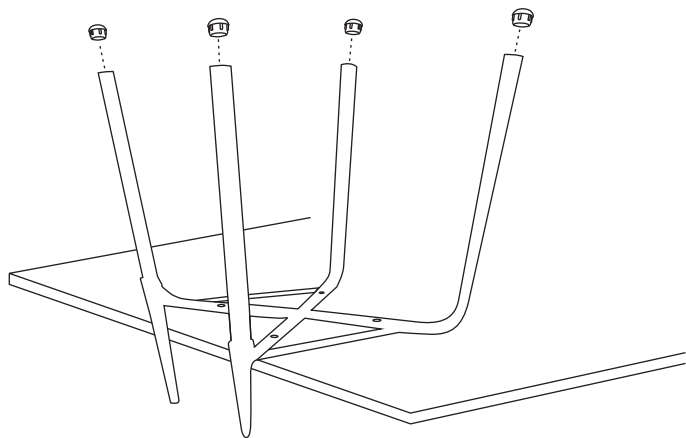
Passo 02: Encaixar o encosto (item 01), no suporte da estrutura (item 4), conforme ilustração.

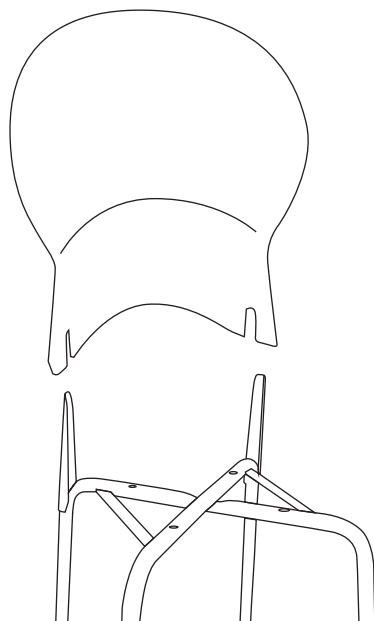

Passo 03: Com o encosto já encaixado, fixar o assento (item 2) na estrutura (item 4).

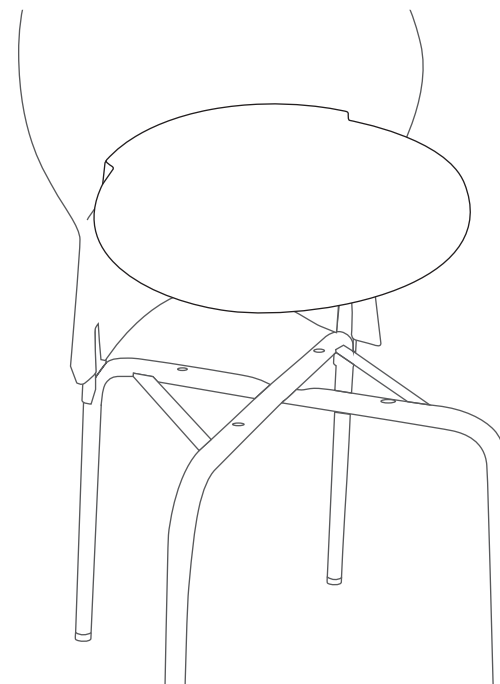

Passo 04: Para finalizar a montagem posicionar a cadeira sobre uma mesa (conforme ilustração) e fixar 4 parafusos (item a).

