

Como boa prática de montagem, recomendamos que na fixação de parafusos em roscas metálicas, seja utilizado trava química. Este cuidado evita que o parafuso se solte prematuramente.



Av. das Indústrias, 337 - Bariri-SP  
+55 14 3662-9000







frisokar

ISO  
Linha MULTIFUNCIONAL

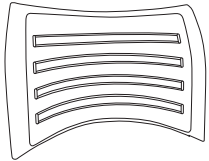
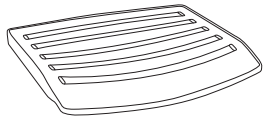
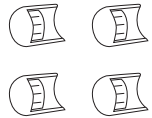
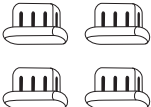

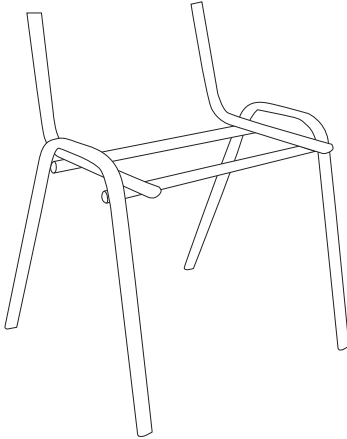
revisão: agosto/2018

<p>01</p>  <p>encosto PP</p>	<p>02</p>  <p>assento PP</p>	<p>03</p>  <p>tapa tubos</p>
<p>04</p>  <p>sapatos</p>	<p>05</p>  <p>plugs de acabamento</p>	<p>06</p>  <p>insertos LD / LE</p>
<p>07</p>  <p>estrutura fixa</p>		<p>a)</p>  <p>parafusos philips pan 5x20 AA mitoplastic (x4)</p>

**Passo 01:** Posicionar a estrutura fixa (item 07) sobre um apoio, em seguida encaixar as sapatas (item 04) e bater com martelo de borracha para melhor fixação.

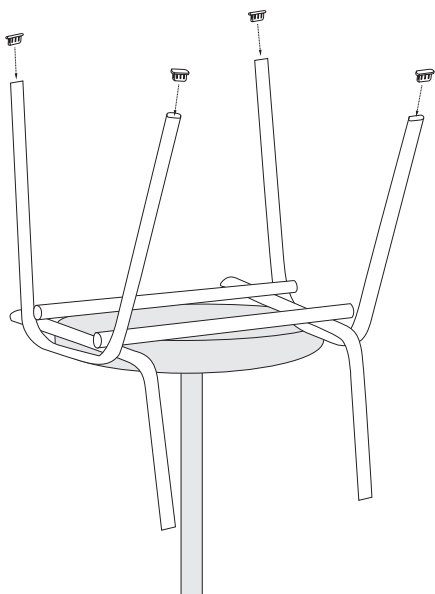

**Passo 02:** Inserir os tapa tubos (item 03) nas laterais da estrutura fixa (item 07).

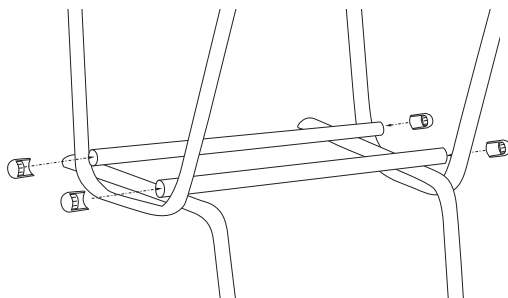

**Passo 03:** Posicionar e encaixar o assento (item 02) sobre a estrutura (item 07). Para o correto encaixe do assento, exercer pressão com as mãos sobre os locais indicados na figura ilustrativa, até o encaixe total.

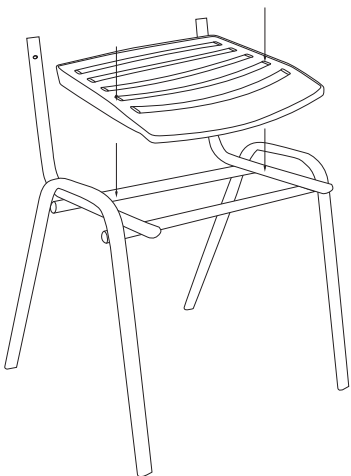

**Passo 04:** Parafusar o assento (item 02) à estrutura (item 07), com os parafusos (item a).

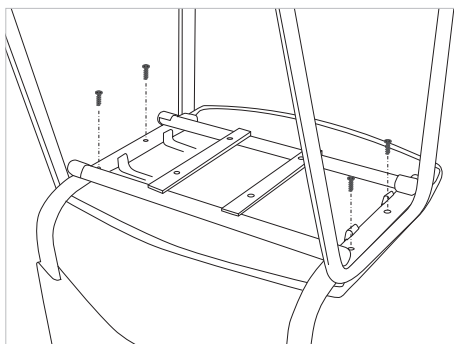

**Passo 05:** Encaixar o insertos (item 06) na estrutura fixa (item 07). Obs.: As laterais maiores dos insertos, sempre posicionadas para as extremidades.

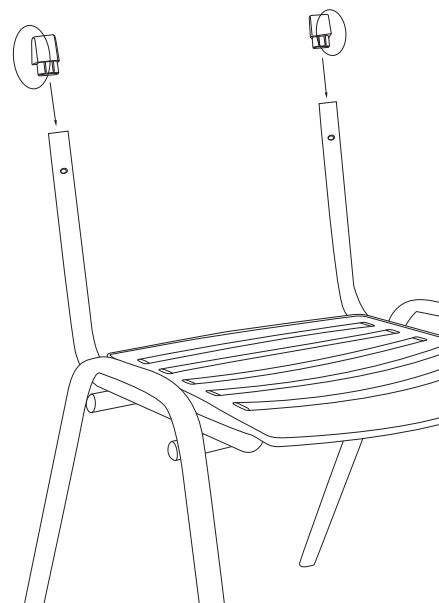

**Passo 06:** Posicionar e inserir simultaneamente os encaixes do encosto (item 01) à estrutura fixa (item 07), alinhando os furos do encosto aos furos da estrutura.

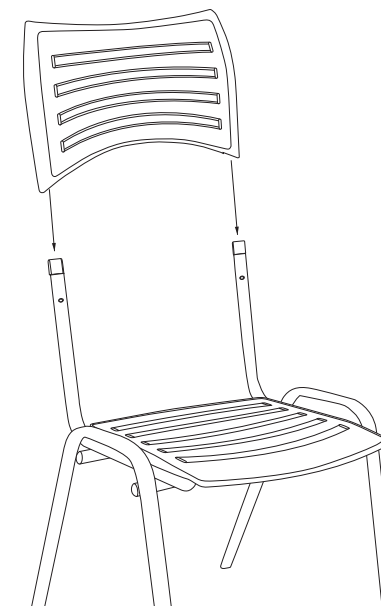

**Passo 07:** Fixar os plugs (item 05) no encosto (item 01), manter os lados maiores dos plugs nas extremidades do encosto.

